

**Touch Keypad TFT Color
Display GSM&PSTN
Burglar Alarm System
(ALN-8218G)**

User Guider

Table of the content

Identification Section-----	4
1. Summarize-----	6
2. System Features-----	6
3. Alarm system setup-----	6
4. Alarm Process-----	8
4.1 Alarm process description-----	8
4.2 Alarm SCHEMATICS-----	9
5. Alarm System Operation and settings-----	9
5.1 Alarm Panel Initial Setup-----	9
5.2 Arm-----	9
5.3 Stay Arm-----	10
5.4 Disarm-----	10
5.5 Emergency alarm-----	10
5.6 Phone number settings-----	10
5.6.1 Set up voice alarm phone number-----	11
5.6.2 Delete voice alarm phone number-----	11
5.6.3 Set up Contact ID phone number-----	11
5.6.4 Delete Contact ID phone number-----	11
5.6.5 Set up for help alarm phone number-----	11
5.6.6 Delete for help alarm phone number-----	11
5.6.7 Set phone number to receive SMS message-----	11
5.6.8 Delete SMS phone number-----	12
5.6.9 Voice call-----	12
5.7 Pre-record Voice Message-----	12
5.8 Add Accessories-----	12
5.8.1 Add Remote Control-----	12
5.8.2 Delete the remote control-----	13
5.8.3 Add detector-----	13
5.8.4 Delete detector-----	13
5.9 Set delay for system arm-----	13
5.10 Set the alarm system password-----	13
5.11 Set Password modification-----	13
5.12 Set keyboard password protection feature-----	14
5.13 System voice volume adjustment-----	14
5.14 Set system voice ON or OFF-----	14
5.15 Set the external alarm volume-----	14
5.16 Set the internal alarm volume-----	14
5.17 Set length of Siren sound-----	14
5.18 Set number of ring tones for remote-----	14
5.19 Set the anti-tampering of telephone cord ON/OFF-----	14
5.20 Set the SMS Messaging reply ON/OFF-----	14
5.21 Set alarm Output ON/OFF-----	14

5.22	Set remote control accompanying sound	15
5.23	Scheduled arm and disarm time setting	15
5.24	Set CID number	15
5.25	Set the Hand shake Tone	15
5.26	Set the mode of uploading arm/disarm message	15
5.27	Set scheduled self-checking Test Time	15
5.28	Set scheduled self-checking Test Week	15
5.29	Set the LCD save ON/OFF	15
5.30	Set Tamper ON/OFF	15
5.31	Restore factory setting	16
5.32	Total System Reset	16
5.33	Set the type of defense zone	16
5.33.1	Setting CID event codes	16
5.33.2	Set siren ON/OFF when Arming	16
5.33.3	Set the type of defense zone	16
5.33.4	Set zones dial calling number group	17
5.33.5	Set wired zone alarm model NO alarm/NC alarm	17
5.34	Set the time of alarm system	17
5. 35	Query alarm history list record	17
5. 36	Query Arm and Disarm history record	17
5. 37	SMS commands	17
5.37.1	Set phone alarm number	18
5.37.2	Set center number	18
5.37.3	Set helpline number	18
5.37.4	Set SMS alarm number	18
5.37.5	Set the password	18
5.37.6	Set delay arm time	18
5.37.7	Set delay alarm time	18
5.37.8	Set length of Siren sound	18
5.37.9	Set the date and time	18
5.37.10	Scheduled arm and disarm time setting	18
5.37.11	Set the type of defense zone	19
5.37.12	Set mode of wired alarm zone	19
5.37.13	Zone setting	19
5.37.14	Volume control of the voice prompt	19
5.37.16	Power saving mode setting	19
5.37.17	Volume adjustment of Internal siren	19
5.37.18	Set the mode of uploading arm/disarm message	20
5.37.19	Set CID center account	20
5.37.20	Self-checking time setting	20
5.37.21	Set the number of ring tones before picking up	20
5.37.22	Restore the factory setting	20
5.37.23	Arm	20
5.37.24	Disarm	20

5.37.25	Stay arm-----	20
5.37.26	Turn on relay-----	20
5.37.27	Turn off relay-----	20
5.37.28	Query the General Parameters -----	20
5.37.29	Query the number of ring tones and test line-----	20
5.37.30	Query the phone alarm number -----	20
5.37.31	Query the Helpline number -----	20
5.37.32	Query SMS number -----	20
5.37.33	Query alarm center number-----	20
5.37.34	Query the system date and time-----	20
5.37.35	Query the scheduled time of arm and disarm-----	20
5.37.36	Query the defense zone type-----	21
5.37.37	Query the alarm mode of the wired zone-----	21
5.37.37	Query the alarm mode of the wired zone-----	21
5.37.39	Query the SMS message content of every zone -----	21
5. 38	Remote Control of Panel-----	21
5. 39	System default zone types-----	21
5. 40	System default setting-----	21
5. 41	Fitting parameters-----	21
6 .	Guideline for Installing Door or Window Sensor-----	22
7.	Guideline for Installing PIR Motion Sensor-----	22
8 .	Troubleshooting-----	23

Identification Section:

Control Panel: Receiver and control center of alarm system

Remote Control: Applied to switch the status of arm, disarm, stay and for emergency alarm. Need to learn to the control panel first.

Detector: Install detector in the detection area, sent alert to host once detector was triggered. Such as PIR detector, door sensor, gas detector, smoke detector etc. Need to learn to the control panel first.

Arm: Any detectors were triggered, host alarm.

Disarm: System alarms only when the detectors in emergency defense zone and help senior defense zone were triggered. Detectors in other defense zone triggered will not alarm.

Stay Arm: System alarm only when detectors in stay defense zone were triggered. Other defense zones not.

Alarm number: Number dialed when host alarm

Centre number: Upload information to Centre number when host alarm

Assistance number: Number dialed when detector in help senior defense zone was triggered

SMS number: SMS message sent to telephone number when host alarm

Voice Call: Host can be used as an normal mobile phone

Delay for system arm: When user set the alarm system in the status of arm by remote control or keyboard, control panel will delay a period of time for arming.

Time of delay for alarming: When detector triggered, the host delay a period of time to alarm

Long-distance Control: Call host number by telephone or phone, can control the control panel when host number picking up.

System Password: System default password 1234

System Volume: Volume of voice prompt while operating the host.

System Voice: Voice prompt on/off while operating the host.

Siren beep time: Time for siren alarm, unit is minute.

Number of ring tones: Number of ring tones before picking up when setting the host by telephone or Phone.

Offline Detection: Alarm ON/OFF when detecting telephone line fault

SMS Reply: Enable or disable SMS reply when user set the host via SMS message

Alarm output: Relay output On/Off when alarm

Remote Control Audio: Arm/Disarm by remote control, voice prompt the operation, at the same time enable or disable the siren.

Scheduled Arm/Disarm: Set a period of time for arm/disarm, host automatically change the status of arm/disarm.

User Code: Code of the host in CID center, consist of 4 numbers

Centre Accuracy: Requirement for accurate signal when change information between host and CID Center.

Arm/Disarm Upload: When status of arm/disarm change, upload the information to CID or not

Self Test Time: will regular upload the info to CID for smooth connection

Self Test week: will regular upload the info to CID for smooth connection

Power saving back light: auto-close the back light if no operation

Tamper Switch: the panel has a tamper swith, will alarm if moved it

Record: Support ISD automatic voice mailbox for playback message upon alert

Network code: defined the alarm attributes(such as burglar alarm, fire alarm) by three-digit numbers

Build-in siren: can setup to ring the siren or not when alerting.

Defense Zone Type: 8 types Defence zone optional

NORMAL Defense Zone: The Panel only works on the arming status. When disarming, there is no response.

STAY Defense zone: Can be shut off solely through the remote control (keyboard) to avoid the Infrared Detectors and other in-room detectors from misinformation when master is resting at home.

INTELLIGENT Defense zone: If the detector in the Defense zone is triggered only once, it will not immediately alarm. But if being triggered once again within 30 seconds after the first triggering, it will alarm immediately.

EMERGENCY Defense zone: No matter on arming or disarming status, if detector is triggered it will alert. Usually used in connecting with Smoke Detectors, Gas Detectors and emergency button, etc.

CLOSED Defense zone: No matter arming or disarming status, detectors will not alert even being triggered.

CHIME Zone: No matter in what status, when sensor with this zone is triggered, a welcome door bell will be ring as notification.

WELCOME Zone: Working on the disarming status, when sensor with this zone is triggered, a welcome voice message will be played. While in arming status, system alarms.

HELP SENIOR Defense Zone: This type of zone is for elderly safety, no matter in what status, the panel will alarm once sensor with this zone type is triggered. System automatically dial 3groups help senior number, once the phone picked up, it remind with voice of “someone need help”

Specific number to certain zone: Set voice alarm phone number for specific defense zone, help senior defense zone dial 3 groups number.

System Time: Alarm panel system time

Alarm Record: Alarm message recorded by control panel, including defense zone and alarm time. Can display 102 groups call logs.

Arm/disarm Record: Time and mode of every arm/disarm recorded by the host. Can display recent 72 groups records.

1. Summarize

1. 7 inch TFT color display, touch screen keypad, built-in high performance CPU, this high-end dual-network GSM/PSTN alarm system has reliable performance and favorable operability. It connects with wireless infrared detector, door sensor, smoke detector, gas detector, emergency button and other accessories. When the detector is trigger, the alarm system will notify the user by 120 decibels alarm sound and at the same time a call and SMS message will be sent to the user. It is a choice of stability, reliability, security, and user friendliness security product. Features are very practical, cost-effective, completed configuration and ease of use. It has been widely used in homes, factories, schools, shops, convenience stores, financial and banking workplace, community center and residential area to provide protection to valuable assets.

2. System Feature

- TFT color display, humanized menu, voice prompt and easy to use.
- Up to 99 wireless zones, each wireless zones can be defined as one of the 8 zone types, each zone can setup the siren independently.
- Four sets of scheduled arm/disarmed function, each timed arm/disarm you can select the period of time and different defense zone
- 6 groups preset telephone number for alert calling; not lost number without power
- Support ISD automatic voice mailbox for playback message upon alert. Maximum length of voice message is 10 seconds.
- Remote control for arming, disarming, monitoring and speaking, setting up for relay and siren.
- Wireless intelligent study coding, compatible with PT2262 normal encoding and 1527 encoding, Maximum support 150 remote control and 150 sensors.
- Integrated clock chip,time will not lose without power
- Unique black box feature, display most recent 72 disarmed records and 102 recent alarm recording with accurate alarm time and zones.
- Compatible with the international alarm networking protocol CONTACT ID

3. Alarm System Setup

Alarm panel should be installed at a central location with best transmission to all the wireless sensors and accessories. Keep the panel away from large metal objects or household appliances with high-frequency interference, and avoid barriers such as concrete walls with metal frame inside and fire doors.

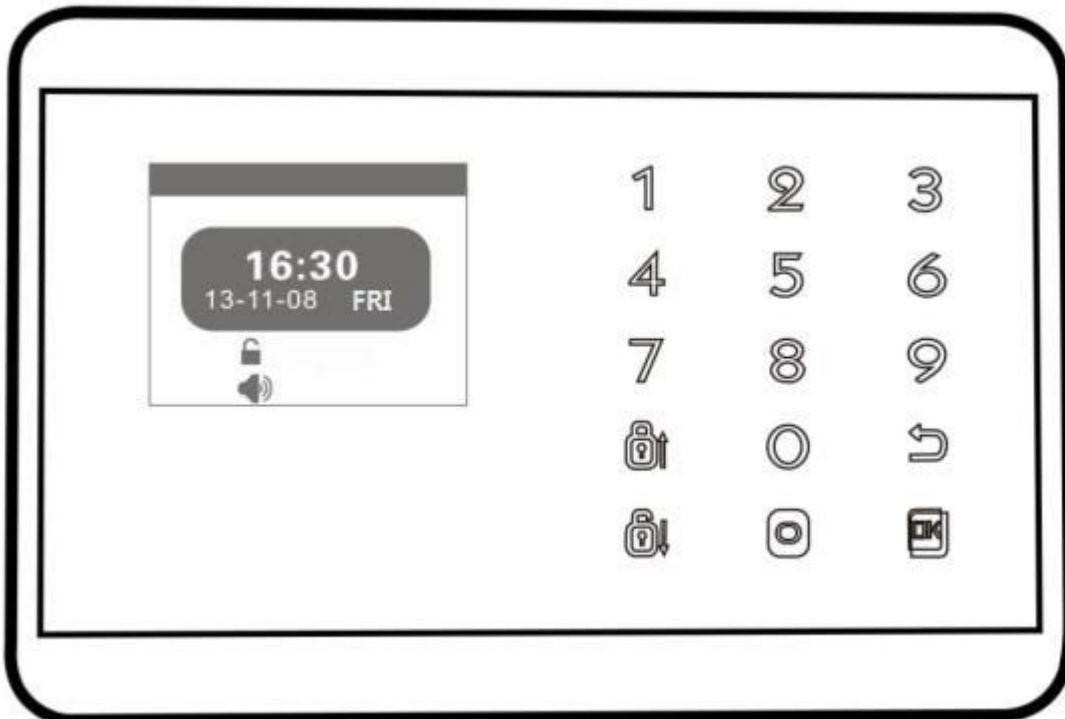

The front figure of the host

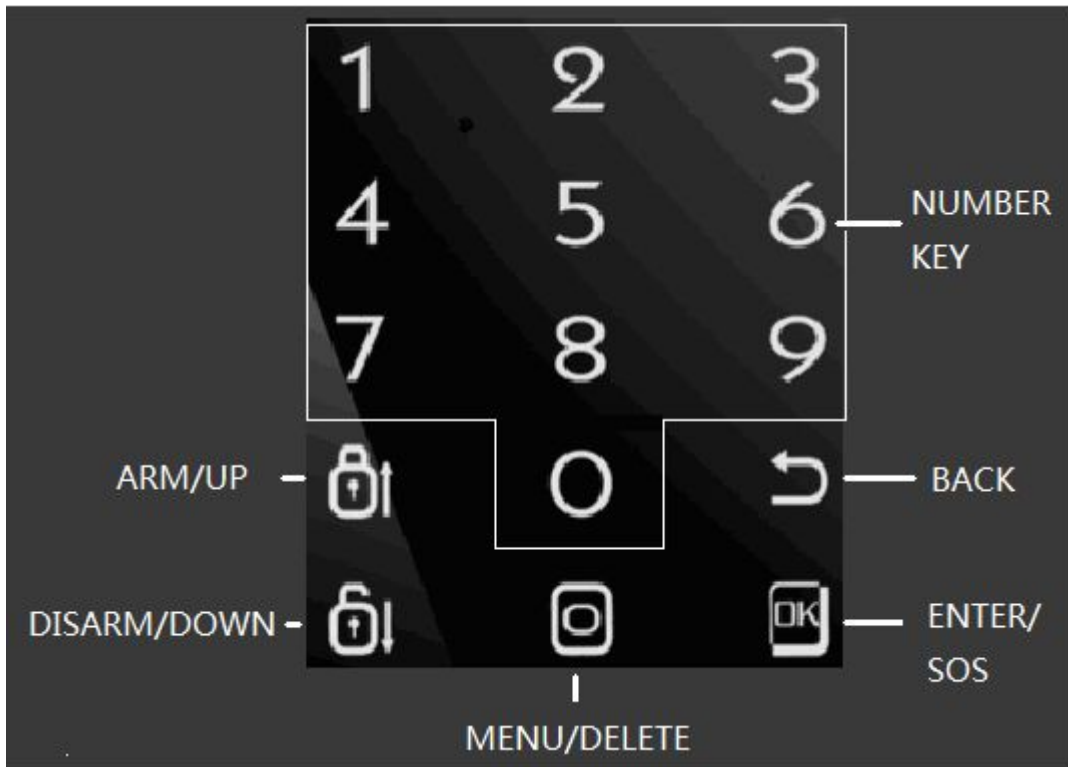

The touch-key figure of the host

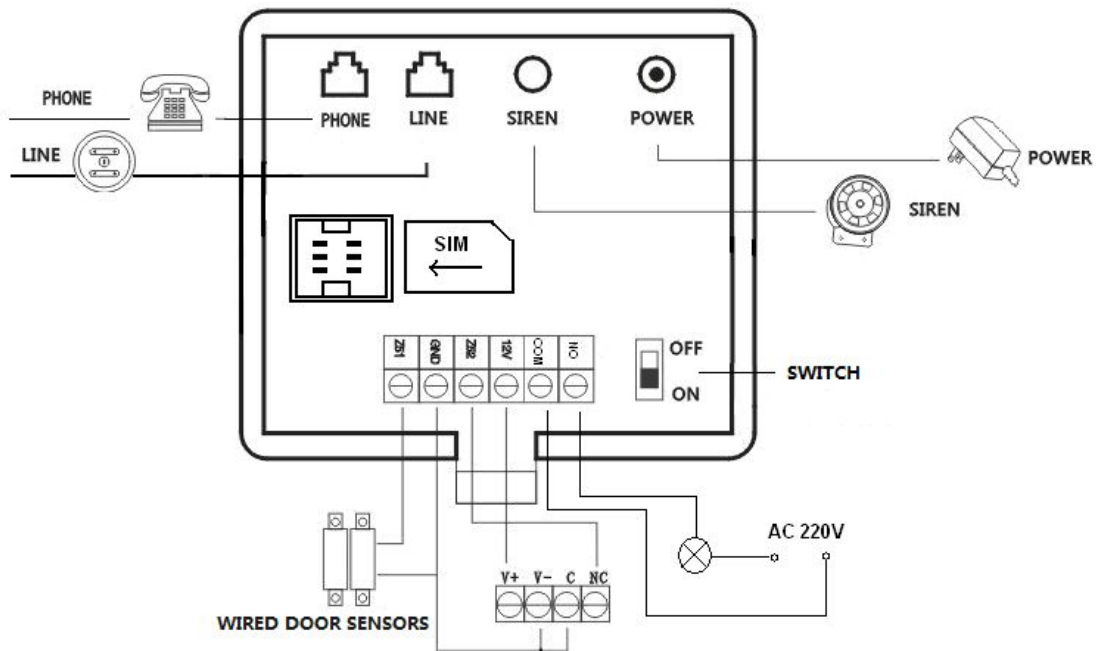

the connection method of wired door sensor and PIR sensor

■Notice

TFT display	Display "DISARM"	Alarm host in DISARM status
	Display "ARM"	Alarm host in ARM status
	Display "STAY ARM"	Alarm host in STAY ARM status
	Display "XX zone arming"	XX zone in a ARM status,
	Display"98 zone arming"	Emergency arming by pressing the emergency button
	Display"97 zone arming"	The host was defused or moved
	"SIM Card" light	SIM Card loaded correctly

4 Alarm Process

4. 1 Alarm process description

- 1、 The host is in ARM status
- 2、 When the detectors was triggered, the alarm will send to host by wired or wireless
- 3、 The host will alert
- 4、 The host upload the alarm to the CID center
- 5、 The host call/SMS to the user
- 6、 Tthe user can remote control the host after picked up the phone

After Panel alerts, it will automatically dial the preset telephone number for three times until connected. When the user picks up the phone, a piece of pre-recorded voice message will be played back immediately and let the receiver noted about the event. Upon receiving the call, it can also control the alarm panel remotely via the phone (according to the command below). User will not be asked for password upon connected and alarm will automatically hang up call within receiving any instruction within 20 seconds.

- | | |
|---|--------------------------------|
| [1] key: arming | [2] key: disarming |
| [3] key: monitoring open | [4] key: monitoring closed |
| [5] key: turn on announcement | [6] key: turn off announcement |
| [7] key: siren ringing | [8] key: stop siren sound |
| [9] key: turn on relay | [0] key: turn off relay |
| [*] key: hang up, system will not dial the next number on list. | |

Remark:

If not hang up using [*] key or disarm using [2] key, the system will retry to call the next phone numbers on list until one connected.

Note: the monitoring and announcement time is 20 seconds, please press [3] or [5] key to continue if you need.

4.2 ALARM SCHEMATICS

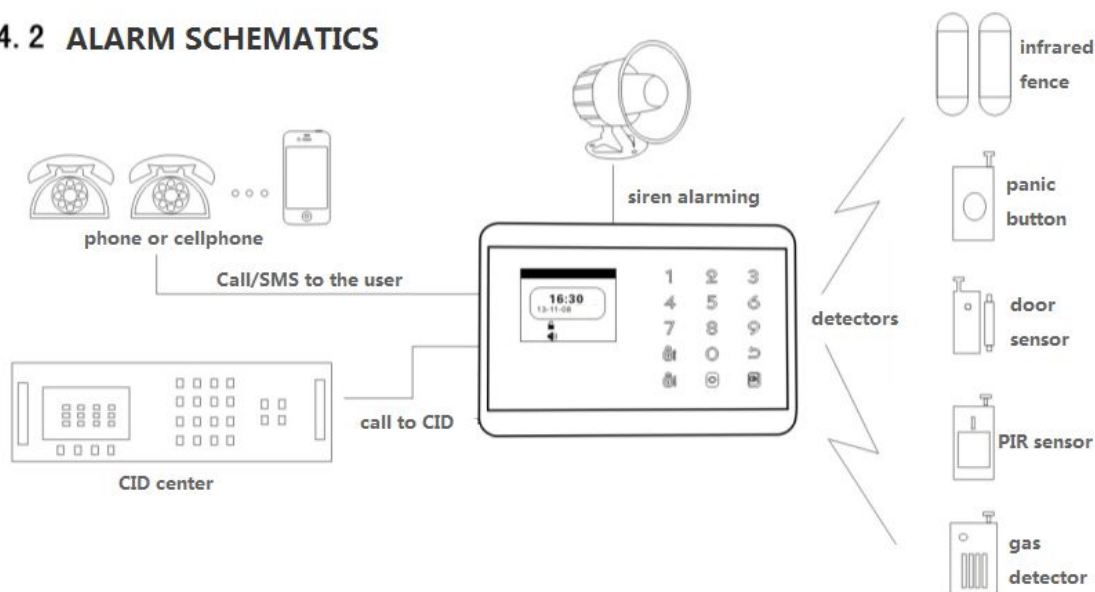

5 Alarm System Operation and settings

5.1 Alarm Panel Initial Setup

At first, Connect the telephone line to the perimeter phone interface of the host, and connect telephone to the inside phone interface. Secondly, connect the siren to the siren interface, and plug in adapter. At last, the host will voice prompt “welcome to use alarm system”, then it’s done after switch the power switch to “ON”.

insert the power adapter output of electricity host power supply hole at this point, the host voice prompt welcome to use intelligent voice alarm, the backup battery switch to [ON]

5.2 ARM

The system is at a fully ready status where all detectors are activated in a working state, when the some events (burglar, fire, gas leak, etc) happened and detected, alarm system alarm right away. In ARM status, the host will display “ARM”,

To activate by remote control: press “ARM” key once.

To activate by keyboard: on panel keyboard “DISARM” keys once.

5.3 DISARM

All sensors are deactivated and will not be respond to any events.(expect the detector in Emergency zones and the Panic button in the remote control (In a DISARM status, the host will display “DISARM”).

To activate by remote control: press “DISARM” key once.

To activate by keyboard: press “DISARM” keys once.

5.4 STAY ALARM

This is for partial arming of the alarm system when there are people at home, only some of the selected sensors are activated and could be triggered by events.

In a STAY ARM status,the host will display “STAY ALARM”,

To activate by remote control: press “STAY ALARM” key once.

To activate by keyboard: press “STAY ALARM” key once.

5.5 Emergency alarm

When an emergency occurs, press emergency button on the remote control or on panel to activate alarm.

Remark: If password protect function is open, you need to enter password before other operations, the initial password is 1234.

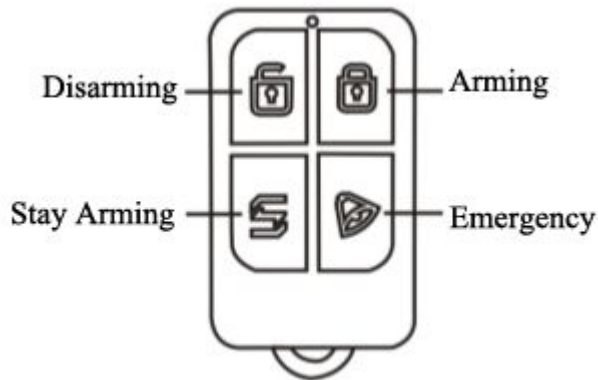

5.6 Phone Number Settings

The model can support 6 groups of alarm numbers, 2 groups CID numbers, 3 groups help numbers, 6 groups SMS numbers. Each phone number shouldn't exceed 31 digits. As follow:



Picture 5-1

5.6.1 Set up voice alarm phone number

As picture 5-1, Press **[menu]** to enter main menu, Press **[Up/Down]** move the cursor to **[1. Alarm numbers]**, press **[OK]** or number **[1]** to enter Alarm number settings, choose group number 1-6, then input alarm number like 13812345678. Press **[OK]** to save, press **[ESC]** can back to the menu.

Remark : For users who use the telephone line extension, you should dial a number (such as "9") to pick up a dialing tone, press **[Arming]** to add a "*", then input the alarm number.

5.6.2 Delete voice alarm phone number

As picture 5-1, enter **[Alarm number]**, press **[menu]** button to delete the number than press **[OK]** to save the settings. Press **[ESC]** can back to the menu.

5.6.3 Set up Contact ID phone number

As picture 5-1, Press【menu】to enter main menu, Press【Up/Down】move the cursor to【2. CID numbers】, press 【OK】 or number 【2】 to enter CID number settings, choose group number 1-2 , then input CID number like 88889999. Press 【OK】 to save, press 【ESC】 back to the menu.

Remark : For users who use the telephone line extension, you should dial a number (such as "9") to pick up a dialing tone, press 【Arming】 to add a “*”, then input the alarm number.

5.6.4 Delete Contact ID phone number

As picture 5-1, enter【CID number】, press【menu】button to delete the number than press【OK】to save the settings. Press 【ESC】 back to the menu.

5.6.5 Set up for help alarm phone number

As picture 5-1, Press【menu】to enter main menu, Press【Up/Down】move the cursor to【3. CID numbers】, press 【OK】 or number 【3】 to enter help number settings, choose group number 1-3 , then input help number like 13812345678. Press 【OK】 to save, press 【ESC】 back to the menu.

Remark : For users who use the telephone line extension, you should dial a number (such as "9") to pick up a dialing tone, press 【Arming】 to add a “*”, then input the alarm number.

5.6.6 Delete for help alarm phone number

As picture 5-1, enter【Help number】, press【menu】button to delete the number than press【OK】to save the settings. Press 【ESC】 back to the menu.

5.6.7 Set phone number to receive SMS message

As picture 5-1, Press 【menu】 to enter main menu, Press 【Up/Down】 move the cursor to 【4. SMS numbers】, press 【OK】 or number 【4】 to enter SMS number settings, choose group number 1-6 , then input SMS number like 13812345678. Press 【OK】 to save, press 【ESC】 back to the menu.

Remark : For users who use the telephone line extension, you should dial a number (such as "9") to pick up a dialing tone, press 【Arming】 to add a “*”, then input the alarm number.

5.6.8 Delete SMS phone number

As picture 5-1, enter【SMS number】, press【menu】button to delete the number than press【OK】to save the settings. Press 【ESC】 back to the menu.

5.6.9 Voice call

As picture 5-1, Press【menu】to enter main menu, Press【Up/Down】move the cursor to【5. Voice calls】, press 【OK】 or number 【5】 to enter , then input number like 13812345678. Press 【OK】 to dial, press 【ESC】 hang up the call.

5.7 Pre-record Voice Message

Alarm panel will play a pre-recorded voice message in the alarm call. As follow:



Picture 5-2

As picture 5-2, press **【menu】** to enter main menu. Press **【4】** to enter message recording, and then press **【1】** to start recording , speak your message to the panel for recording.

System will record 10 seconds and then automatically exit. Message should be simple like “This is whose house be intruded, please help”.

5.8 Add Accessories



Picture 5-3

5.8.1 Add remote control

As picture 5-3, Press **【menu】** to enter main menu. Press **【2】** to enter Add accessories.

Press**【1】**to enter add remote control, the menu would be indicate that "type the Number (00~99)", if add 1st remote control, please input 01, add 22th remote control, please input 22, then press **【OK】** to save the settings. Then press any key of the remote control to send a signal to the alarm panel, voice prompt "Set successful" and LCD display "has been saved" means add successful. If beep only once means this remote control has been configured before and cannot be added again. If want to add more remote control, can press any key of other remote control. Alarm panel can configure up to 150 remote control of different coding.

5.8.2 Delete the remote control

As picture 5-3, press **【3】** to enter Del remote control, then display "type the Number (00~99)". If delete 1st remote control, please input 01; delete 22th remote control, then input 22; press **【**】**(Input **【Arming】** as “*”) to delete all remote controls. Later press **【OK】** to delete certain zones remote control or all remote controls.

5.8.3 Add detector

As picture 5-3, press **【2】** to enter add detector , the menu would be indicate that "type the Number (00~99)", if add 1st detector , please input 01; add 89th, input 89. Press **【OK】** to save the settings. Then press any key of the detector to send a signal to the alarm panel, Panel beep twice, voice prompt "Set successful" and LCD display "has been saved" means successful. If beep only once means this detector has been configured before and cannot be added again. If want to add more detector, can press any key of other detector. Alarm panel can configure up to 150 detectors of different coding.

5.8.4 Delete detector

As picture 5-3, press **【4】** to enter Delete detector, then display "type the Number (00~99)", if delete 1st detector, please input 01; delete 89th, input 89; press **【**】**(Input **【Arming】** as “*”) to delete all detectors. Then press **【OK】** to delete certain zones detector or all detectors.

5.9 Set delay for system arm

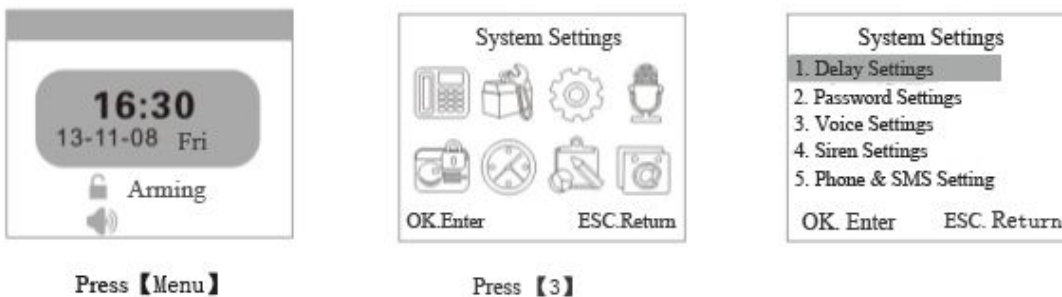

Picture 5-4

As picture 5-4, choose **【1.Delay settings】** , input the delay time from 0 to 99 seconds after **【Arming delay】** , “0” means arming without delay.

5. 10 Set the time of delay for alarming

As picture 5-4, press **【1.Delay Setting】**, press the **【OK】** to move cursor behind **【Alarm Delay】**, then input the delay the number of seconds(0-99 seconds), 0 means no delay.

5. 11 Set the alarm system password

As picture 5-4, press **【2.Password Setting】**, input four new password behind **【Password】**(the original password is 1234).

5. 12 Set keyboard password protection feature

As picture 5-4, press **【2.Password Setting】** ,then press **【OK】** to move cursor behind **【Keypad Lock】** ,Press the **【Menu】** switch ON or OFF.

5. 13 System voice volume adjustment

As picture 5-4,press **【3.Voice Setting】** , press **【OK】** to move cursor behind **【System volume】** .then input the volume level 1-7 ,1 is minimum volume,7 is maximum volume.Press **【OK】** to save

5. 14 Set system voice ON or OFF

As picture 5-4,press【3.Voice Setting】,then press【Down】move the cursor behind【System voice】,press【Menu】 switch ON or OFF.OFF means the alarm system no voice in the operation, but with the press sound.

5. 15 Set the external alarm volume

As picture 5-4,press 【4.Siren Setting】,press 【OK】 button move the cursor to 【External volume】,input the volume level 00-99,00 means mute, 99 the maximum sound.press 【OK】 to save

5. 16 set the internal alarm volume

As picture 5-4,press 【4.Siren Setting】,press 【Down】button move the cursor to 【Built-in volume】,then input the volume level 00-99,00 means mute, 99 the maximum sound

5. 17 Set length of Siren sound

As picture 5-4,press 【4.Siren Setting】,press 【Down】button move the cursor to【Siren on time】,input 0-20 minutes.0 is means no siren sound after alarm

5. 18 Set number of ring tones for remote

As picture 5-4,press 【5.Phon&SMS setting】,press 【OK】 button move the cursor behind 【Ring time】,then input the number of ring tones 1-20 ,0 indicates the host don't accept the cable remote set functions, 20 means the host is on the phone after received 20 times rings in continuous

5. 19 Set the anti-tampering of telephone cord ON/OFF

As picture 5-4,press 【5.Phon&SMS setting】,press 【Down】button move the cursor to【Test line】,press【Menu】 switch ON or OFF

5. 20 Set the SMS Messaging reply ON/OFF

As picture 5-4,press 【5.Phon&SMS setting】,press 【Down】 move the cursor to【SMS reply】,press【Menu】switch ON or OFF .On is means user sent the setting message to the alarm system host,the host will reply the setting is correctly.

5. 21 Set alarm Output ON/OFF.

As picture 5-4,press 【5.5.Phon&SMS setting】,press 【Down】 move the cursor to【Alarm Out】,press【Menu】 switch ON or OFF,On is means when the system is alarm, relay will short circuit output at the same time(COM and CO short circuit output)

5. 22 Set remote control accompanying sound



Picture 5-5

As picture 5-5,press【6.sound setting】,The menu prompts "Enter number(00-99)"then press 【OK】,press 【Menu】 switch ON or OFF,On is means press the remote control in these number,the siren will sound "di di".

5. 23 Scheduled arm and disarm time setting

As picture 5-5,press 【7.Timing Setting】 ,The menu prompts "Enter Number(1-4)",then press 【OK】 ,input the Arming, Time,Disarm time,Week. (press 【Menu】 switch On or OFF)

5. 24 Set CID number

As picture 5-5,press 【8.CID setting】 ,input four number CID coding behind 【User Coding】 ,then press 【OK】 to save.

5. 25 Set the Hand shake Tone

As picture 5-5,press 【8.CID setting】 ,then 【OK】 ,Input the (0-9) to behind 【Hand shake Tone】 ,Press 【OK】 to save.

5. 26 Set the mode of uploading arm/disarm message

As picture 5-5,press 【8.CID setting】 ,then 【OK】 ,move the cursor behind 【Arm&Disarm】 ,then press 【Menu】 switch 【No sent】 / 【Arm】 / 【Disarm】 / 【All】 ,press 【OK】 to save

5. 27 Set scheduled self-checking Test Time

As picture 5-5,Press 【8.CID setting】 ,then press 【OK】 ,move the cursor behind 【Test Time】 ,input the self check test time,then press 【OK】 to save

5. 28 Set scheduled self-checking Test Week

As picture 5-5,Press 【8.CID setting】 ,then press 【OK】 ,move the cursor behind 【Test Week】 ,input the self check test week(1234567),then press 【OK】 to save

5. 29 Set the LCD save ON/OFF

As picture 5-5,press 【9.LCD Save&Tamper】 ,move cursor behind 【Lcd Save】 ,press 【Menu】 switch ON or OFF,Press 【OK】 to save.

5. 30 Set Tamper ON/OFF

As picture 5-5,press 【9.LCD Save&Tamper】,press 【OK】 move the cursor behind 【Tamper】,press 【Menu】switch ON or OFF.OFF is means the host not alarm when the tamper is trigger.Press 【OK】 to save.

5. 31 Restore factory setting

AS picture 5-5,press 【0.Restore Factory】,press 【1】,then press 【OK】,alarm system prompt Restore Factory.

This feature will restore all settings to factory default apart from the configuration of sensors and remote control.

5. 32 Total System Reset

As picture 5-5,press 【0.Restore Factory】,then press 【2】,long press 【OK】 till the the completion of the host to restart.All configuration has been cleared, all sensors and remote controlled are deleted(technique table as 5.40)

5. 33 Set the type of defense zone

Type of defense zone setting is include CID feature codes, Siren On/Off when arming, defense zones types, call number group when arming,wired zones NO alarm or NC alarm. Setting method is as follows:



Picture 5-6

5.33.1 Setting CID event codes

As picture 5-6,input defense zone(1-99)behind 【Enter Number】,press 【OK】,then input the event coding behind 【CID event codes】. 100 is medical aid, 110 is fire alarm, 121 is robbery alarm, 122 is mute robbery alarm, 130 is burglary alarm, 131 is peripheral burglary alarm, 151 is gas alarm

5.33.2. Set siren ON/OFF when Arming

As picture 5-6,input defense zone(1-99)behind 【Enter Number】,press 【OK】,move the cursor behind 【Siren】,press 【Menu】 switch ON/OFF.Off is means the detector in these zone arming,the alarm system not siren.Then press 【OK】 to save.

5.33.3 Set the type of defense zone

As picture 5-6,Input defense zone (1-99)behind 【Enter Number】,press 【OK】,then press 【down】 move the cursor behind the 【Types】.Press 【Menu】 switch 8 kinds type of defense zone.1 normal zones,2 stay arm zone 3, Intelligent zone 4, Emergency zone 5,Closed zone,6,Chime zone,7,welcome zone, 8 Help senior zone.Press 【OK】 to save

5.33.4 Set zones dial calling number group

As picture 5-6,input zones number(1-99) behind **【Enter Number】** ,press **【OK】** ,then press **【down】** move the cursor behind **【Zone dial】** ,input the calling number group when this zones alarm,can be used123456 group,but if the zone type is help zones,the group fixed for the help group.press **【OK】** to save.

5.33.5 Set wired zone alarm model NO alarm/NC alarm

As picture 5-6,Input the wired zones (51-52) behind **【Enter Number】**,press **【OK】**,then press **【down】** move the cursor behind **【Wired model】** ,press **【Menu】** switch the NO alarm / NC alarm.press **【OK】** to save.

5. 34 Set the time of alarm system



Picture 5-7

As Picture 5-7,input the date and time as picture,press **【OK】** to save.

5. 35 Query alarm history list record



Picture 5-8

As picture 5-8,press **【OK】** to History list,press**【Up/Down】**query the alarm history.The maximum 102 history record.

5. 36 Query Arm and Disarm history record

As picture 5-8,press **【Down】** move the cursor behind **【2.Arm&Disarm List】** ,press **【OK】** enter the query arm and disarm history record.press **【Up/Down】** query the arm and disarm record.The maximum 72 history record.

5. 37 SMS commands

You can set the alarm panel to the menu ,also can use SMS message to set it .The following instructions are only for SMS command to control panel remotely:

5.37.1 Set phone alarm number

Syntax :1234+3+group number1-6+phone number+#

Example :to set 13812345678 as the first group phone alarm number ,send message to the alarm panel:12343113812345678#

5.37.2 Set center number

Syntax :1234+4+group number 7-8+phone number +##

Example :to set 13812345678 as the first group center number ,send message to the alarm panel:12344713812345678#

5.37.3 Set helpline number

Syntax :1234+3+group number 7-9+phone number +##

Example :to set 13812345678 as the first group helpline number ,send message to the alarm panel:12343713812345678#

5.37.4 Set SMS alarm number

Syntax :1234+4+group number 1-6 +phone number +##

Example :to set 13812345678 as the first group SMS alarm number ,send message to the alarm panel:12344113812345678#

5.37.5 Set the password

Syntax :1234+50+4digits password +##

Example :to set 9876 as the password ,send message to the alarm panel:1234509876#

5.37.6 Set delay arm time

Syntax :1234+51+0-99 seconds+##

Example :to set the delay arm time for 30s ,send message to the alarm panel:12345130#

5.37.7 Set delay alarm time

Syntax :1234+4+group number 7-8+phone number +##

Example :to set 13812345678 as the first group center number ,send message to the alarm panel:12344713812345678#

5.37.8 Set length of Siren sound

Syntax :1234+53+ 0-20 minutes+##

Example :you want to make a siren sound 5 Minutes. ,send message to the alarm panel:12345305#. Note: if you set it as 0 ,means siren without sound when alarming .

5.37.9 Set the date and time

Syntax :1234+56+4-digits year +1-12 month +1-31day+0-23hours+0-59minutes+0-59 seconds +##

Example :now is 8th Oct 2013,4:38:18 pm,send message to the alarm panel:12345620131008163818#

5.37.10 Scheduled arm and disarm time setting

Syntax :1234+57+Group NO 01-04 + AAAA Scheduled time of arm+BBBB Scheduled time of disarm+week number +#

Example: set up the second group scheduled time to arm at 12 : 00 am and disarm at 18:00 (means 06 : 00 pm), this is valid for Monday, Tuesday, Wednesday, Thursday and Friday of each week. send message to the alarm panel:123457021200180012345#

5.37.11 Set the type of defense zone

Syntax:1234 + 【60】 + 【 00-99 zone number 】 + 【 1-8 Type 】 + 【 0/1 】 + 【 # 】 To set 99 zone type, 00-99 represents 0-99 zone number, 1-8 represents one of the 8 zone type: 1.NORMAL 2.STAY ARM 3.INTELLIGENT 4.EMERGENCY 5.CLOSED 6.CHIME 7.WELCOME 8.HELP SENIOR

The last 0/1 represents 0 siren of panel produce no sound upon alarming while 1 is sounded.send message to the alarm panel:1234601880#.

Example: Set zone number 18th as help senior zone type, and siren not sound upon alarming

5.37.12 Set mode of wired alarm zone

Syntax :1234+61+zone NO +51-52+0/1+# here 0 means NO and 1 means NC

NO means short-circuit to alarm

NC means open-circuit to alarm

Example:set the 51th zone as NO alarm ,send message to the alarm panel:123461511#.

5.37.13 Zone setting

Syntax :[1234]+[64]+[zone NO 01-99] +[CID feature codes AAA]+[#], AAA means CID feature codes 100 is medical aid , 110 is fire alarm , 121 is robbery alarm , 122 is mute robbery alarm , 130 is burglary alarm , 131 is peripheral burglary alarm , 151 is gas alarm

Example : set 38th zone is gas alarm ,send message to the alarm panel:12346438151#.

5.37.14 Volume control of the voice prompt

Syntax :[1234]+[79]+[volume level 1-7] +[#]

Example: set the voice volume to be level 3 . send message to the alarm panel: 1234793#.

5.37.15 Hand shake Tone setting

Syntax :[1234]+[83]+[precision level 0-9] +[#] Example : set it to be 4 ,send the message to the alarm panel:1234834#.

5.37.16 Power saving mode setting

Syntax :[1234]+[84]+[1/0] +[#],

Example: set LCD keeps on ,send the message to the alarm panel:1234840#.

5.37.17 Volume adjustment of Internal siren

Syntax : [1234]+[87]+[volume level 0-7] +[#],

Example :set it as 3,send the message to the alarm panel:1234873#. Note :set it as 0 means internal siren would be not sound when alarming

5.37.18 Set the mode of uploading arm/disarm message

Syntax : [1234]+[91]+[0-3] +[#], Example: Only upload the arm message ,send the message to the alarm panel:1234911#. Here 0 means Don't upload any message 1 Upload the arm message 2 Upload the disarm message 3 Upload the message of ARM/DISARM.

5.37.19 Set CID center account

Syntax :[1234]+[92]+[AAAA 0-9] +[#], Example: set the CID center account as 9988 ,send the message to the alarm panel:1234929988#.

5.37.20 Self-checking time setting

Syntax : [1234]+[94]+[Self-checking time AAAA] +[week number]+[#], Example: set every Sunday 01:00 am ,the alarm system with the alarm center to self-check ,send the message to the alarm panel:12349401007#.

5.37.21 Set the number of ring tones before picking up

Syntax :[1234]+[18]+[0-20] +[#], Example set it to 6 ,send the message to the alarm panel: 12341806#.

5.37.22 Restore the factory setting

Syntax : [1234]+[9898] +[#]

5.37.23 Arm

Syntax :[1234]+[1] +[#]。

5. 37.24 Disarm

Syntax : [1234]+[0] +[#]。

5.37.25 Stay arm

Syntax :[1234]+[2] +[#]。

5.37.26 Turn on relay

Syntax : [1234]+[3] +[#]。

5.37.27 Turn off relay

Syntax :[1234]+[4] +[#]。

5.37.28 Query the General Parameters

Syntax :[1234]+[11] +[#]。

5.37.29 Query the number of ring tones and test line

Syntax :[1234]+[13] +[#]。

5.37.30 Query the phone alarm number

Syntax :[1234]+[30] +[group NO 01-06] + [#]。

5.37.31 Query the Helpline number

Syntax :[1234]+[30] +[group NO07-09] + [#]。

5.37.32 Query SMS number

Syntax :[1234]+[40] +[group NO01-06] + [#]。

5.37.33 Query alarm center number

Syntax :[1234]+[40] +[group NO 07-08] + [#]。

5.37.34 Query the system date and time

Syntax :[1234]+[56]+[#]。

5.37.35 Query the scheduled time of arm and disarm

Syntax :[1234]+[57]+[group NO 01-04]+[#]。

Detailed parameters: The alarm should be compatible with PT2262, PT2240 and EV1527. Using PT2262 encoding, the resistance is recommended 1.5M-4.7M; using with EV1527 encoding, the resistance is recommended 150K-470K.

Alarm loudness: 110dB

Detailed accessories parameters: The alarm should be compatible with PT2262, PT2240 and EV1527. Using PT2262 encoding, the resistance is recommended 1.5M-4.7M; using with EV1527 encoding, the resistance by 150K-470K

6. Guideline for Installing Door or Window Sensor

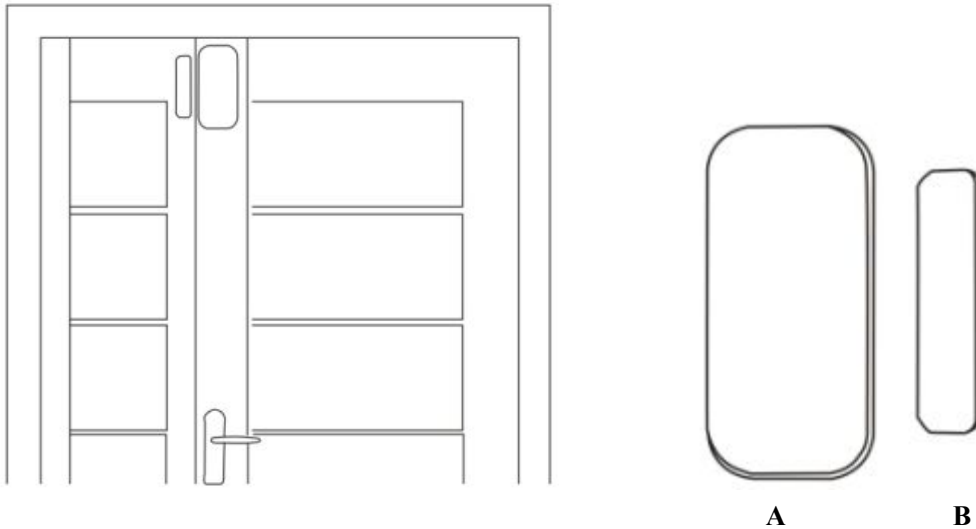

The surface for door sensor installation should be clean so door sensor can be attached to the door and frame firmly with double faced adhesive.

1. Each kit door sensor include sensor (A as in diagram) and magnet (B as in diagram). B must be the right hand side. (A and B, one on fixed door frame, another one on movable door.)
2. A and B must be aline, The distance between A and B not exceeding 1 cm.
3. Upon installed, door sensor should be tested by open the door and check if the indicator on door sensor flashes for 1 second.
4. The indicator light lit for one second, means alarm. In case the door sensor is running out of battery, the indicator should be kept lit as a low-voltage notification.
5. A, B can also be reinforced with screws, (A, bottom out, then screw in the bottom, buckle the cover to the bottom, B can be directly fixed on the screw back.)

7. Guideline for Installing PIR Motion Sensor

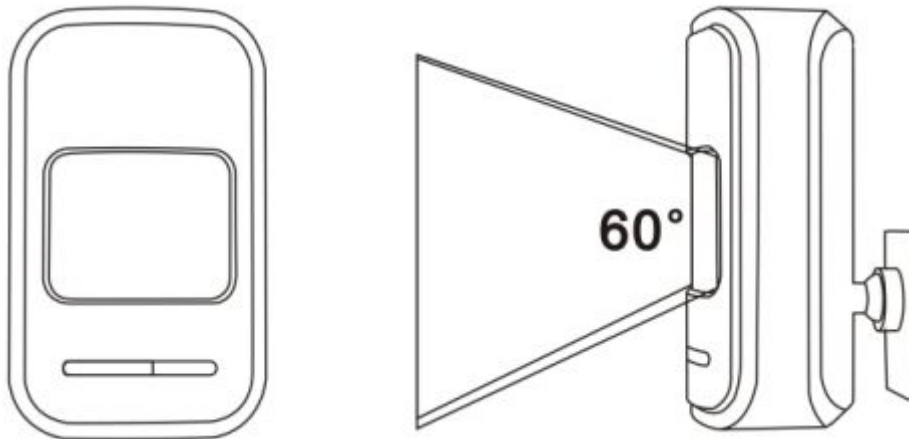

Before use, make sure the power switch of PIR motion sensors is at the ON position.

Installation height is about 2.2 meters above ground and the optimized detection angle for most motion sensor is 90 degree. The sensor should face the detected area with this consideration for best coverage. It is advised to install with the face of motion sensor perpendicular to the most probable moving detection of people for the highest effective detection.

Installation:

Remove the supplied mounting bracket, the bracket is aligned to the detector Bottom screw holes, reinforce bracket with screws. Find the base and reinforce it with two screws in the wall. Press the PIR

with bracket into the center hole of base. and then adjust the best angle of detecting. (This method is suitable for engineering, installation)

Attention:

1. Within coverage of detection, there should be no any objects for obstruction.
2. There should be no two infrared detectors in the same as they will possibly intervene with each other.
3. Avoid the detector facing window, cooling or warming machines, or other appliances that cause the temperature changing sharply and thus cause false alarm.
4. Most infra-red detector needs about 5 minutes to heat up before READY for normal operation.
5. Regular PIR motion sensor is for indoor use unless the specification stated otherwise. Avoid to face to air conditioner.
6. When intruder is detected, PIR will need few seconds to confirm, then transmitter the alarm signal to avoid fault alarm and missed alarm.
7. Unless specifies otherwise, most infra-red detector are indoor use and not reliable to use outdoor.

8 . Troubleshooting

Troubleshooting	Reasons	Methods
1, No dial for alarm	<ol style="list-style-type: none"> 1. no arming 2. alerting phone unsetting 3. parts improperly installed, distance too far away 4. code no match 	<ol style="list-style-type: none"> 1. do arming operation 2. re-set according to the specification 3. coordinating the location of parts 4. re-coding
2, Can't long-distance operate	password input wrongly	password input or changed to new password Or forced always clear factory set back
3, no ISD recorded voice prompt when alerting	ISD Voice prompt un-recorded	Record it again according to user manual
4, remote controller no work	<ol style="list-style-type: none"> 1. coding unmatched with the host 2. insufficient power 3. battery pieces poor contact or corroded 4. unmatched with host 	<ol style="list-style-type: none"> 1. re-coding 2. change battery in the same type 3. eliminating the dirt on the pieces caused by corrosion 4. contact the local dealer to change the matched remote controller
5, infrared detector no work	low power	change to the same type battery
6, Infrared Beams not work	<ol style="list-style-type: none"> 1、 not power on 2、 Electrically shorted 3、 Beam tube dislocation 	<ul style="list-style-type: none"> - Power on - Reconnect wire - Adjust beams
7, siren no sound	<ol style="list-style-type: none"> 1. siren plug or jack in short circuit or broken-line 2. plug line in short circuit 3. siren closed 	<ol style="list-style-type: none"> 1. repair or change plug or jack 2. change the jack line 3. set siren ringing time on the host
8, The transmitter distance for host is shortened	<ol style="list-style-type: none"> 1. a nearby emitter is sending code 2. host receiver stoppage 3. standby battery of the host insufficient 	<ol style="list-style-type: none"> 1. find the interfering source and eliminate it 2. post back to the factory for amendment 3. check host power whether plugged well
9, Consistently alarm once power open	<p>Telephone lines not connected and telephone Lines anti-tamper function activated</p>	connect telephone line or close anti-tamper line function